

5M. POLYGONAL

Model: TUG

HOT DIP GALVANIZED POLE

Without Cross Arm

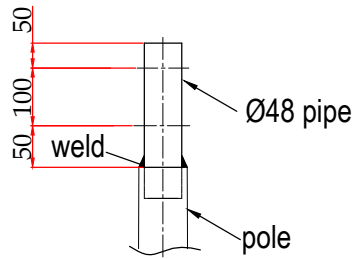
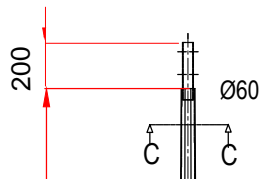

C-C Section

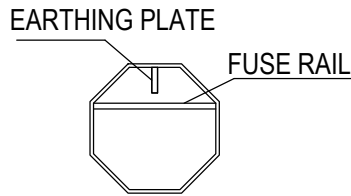

B-B Section

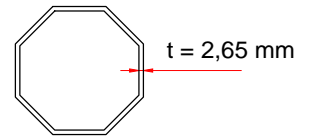

A-A Section

4800

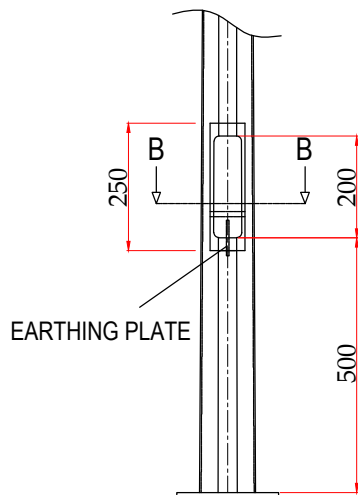

FUSE DETAIL

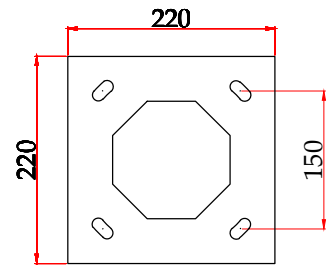

BASE PLATE

8 mm x 220 x 220

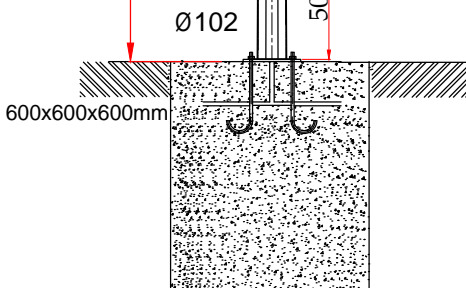

All dimensions mm.

Plate Standard : EN 10025
 Production Standard : EN 40-5
 Galvanizing Standard : EN 1461

ST-O.5M.BASIC MODEL: TUG

without Cross Arm

Steel : S235JR (ST37)

Designed according to the dimensions and the specifications with EUROPE NORM.

Rev : 1